

INDUSTRIAL CEILING FANS

HVLS SUPER BLADE RANGE - NORDIK HD RANGE





VORTICE S.p.A. is part of a multinational group, **VORTICE GROUP**, which operates through its own companies or local distributors in over 90 countries worldwide and has a rich product portfolio that guarantees air quality and climate comfort. The headquarters of VORTICE S.p.A are in Tribiano (Milan).



VORTICE GROUP also includes:

[1] **VORTICE LIMITED**, English branch of VORTICE S.p.A established in 1977 and based in Burton on Trent.

[2] **VORTICE INDUSTRIAL**, born from the acquisition in 2010 of Loran srl, based in Isola della Scala (VR).

[3] **VORTICE Ventilation System**, a company inaugurated in 2013 with headquarters in Changzhou, China.

[4] **VORTICE Latam**, based in Alajuela, Costa Rica, born in 2012.

[5] **CASALS VENTILACIÓN AIR INDUSTRIAL S.L.** historic Spanish brand, based in Sant Joan de les Abadesses, Girona, acquired in 2019.



Index

NORDIK® HVLS SUPER BLADE RANGE Industrial ceiling fans	page 4
Thermal destratification	page 18
NORDIK® HD RANGE Industrial reversible ceiling fans	page 22

Regulatory standards

Industrial ceiling Ventilation products are compliant with the following Directives and Standards in their most recent versions:

- Machinery Directive: No. 2006/42/EC
- Low Voltage Directive: LVD 2014/35/EC
- Electromagnetic Compatibility Directive: EMC 2014/30/EC
- Electrical and Electronic Equipment Waste Directive RAEE 2012/19/EU
- Restriction of Hazardous Substances in Electrical and Electronic Equipment RoHS 2011/65/EU
- Ecodesign Directive 2009/125/EC
- Stand By Directive 2005/32/EC
- Regulation No. 1275/2008
- Regulation 327/2011/EU
- European Regulation No. 2019/1781/EU

NORDIK HVLS

SUPER BLADE RANGE

Industrial fans

Ceiling fans with 5 blades with 300, 400, 500, 600, and 700 cm diameter variants.

Equipped with EC (brushless) motors guaranteeing high performances, low consumption and low noise emissions. Perfect for cooling and keeping temperature balance in wide areas.

Design and manufacturing
MADE IN ITALY



4

NORDIK HVLS SUPER BLADE 300/120" T code 61126
NORDIK HVLS SUPER BLADE 300/120" TL code 61127
NORDIK HVLS SUPER BLADE 300/120" M code 61130
NORDIK HVLS SUPER BLADE 300/120" ML code 61131
NORDIK HVLS SUPER BLADE 300/120" ET code 61143
NORDIK HVLS SUPER BLADE 300/120" ETL code 61144
NORDIK HVLS SUPER BLADE 400/160" T code 61128
NORDIK HVLS SUPER BLADE 400/160" TL code 61129
NORDIK HVLS SUPER BLADE 400/160" M code 61132
NORDIK HVLS SUPER BLADE 400/160" ML code 61133
NORDIK HVLS SUPER BLADE 400/160" ET code 61145
NORDIK HVLS SUPER BLADE 400/160" ETL code 61147

NORDIK HVLS SUPER BLADE 500/200" T code 61134
NORDIK HVLS SUPER BLADE 500/200" TL code 61135
NORDIK HVLS SUPER BLADE 600/240" T code 61136
NORDIK HVLS SUPER BLADE 600/240" TL code 61139
NORDIK HVLS SUPER BLADE 700/280" T code 61137
NORDIK HVLS SUPER BLADE 700/280" ST code 61138
NORDIK HVLS SUPER BLADE 700/280" TL code 61141
NORDIK HVLS SUPER BLADE 700/280" STL code 61142

KEY:

L = Support rode version,
3 m long instead of 1.5 m.
S = Enhanced motor

E = Basic models
M = Single-phase motor
T = Three-phase motor



BENEFITS FOR THE INSTALLER

01

Easy installation

Easy and safe installation

BENEFITS FOR THE USER

01

Reduced consumption

Reduced consumption and full functionality.

02

Energy saving

They cool the environment in summer, while destratifying heat in winter, saving energy

03

Silent

04

Reliable

Reliable, safe and efficient

05

Low maintenance needs

06

Adjustable speed

Guaranteeing maximum comfort and environmental well-being

NORDIK HVLS SUPER BLADE RANGE

LARGE diameters for wide areas, nominal 7 m Ø:

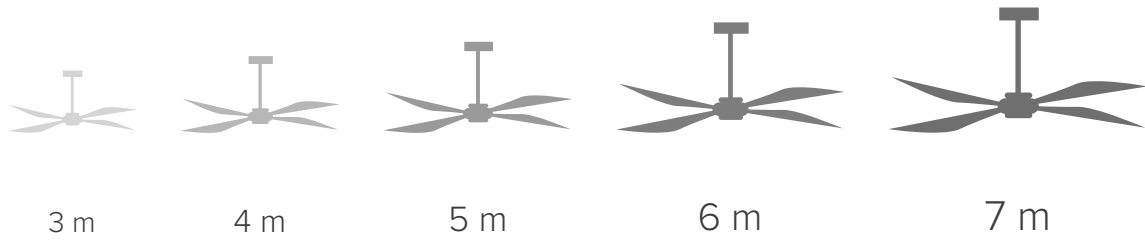

6

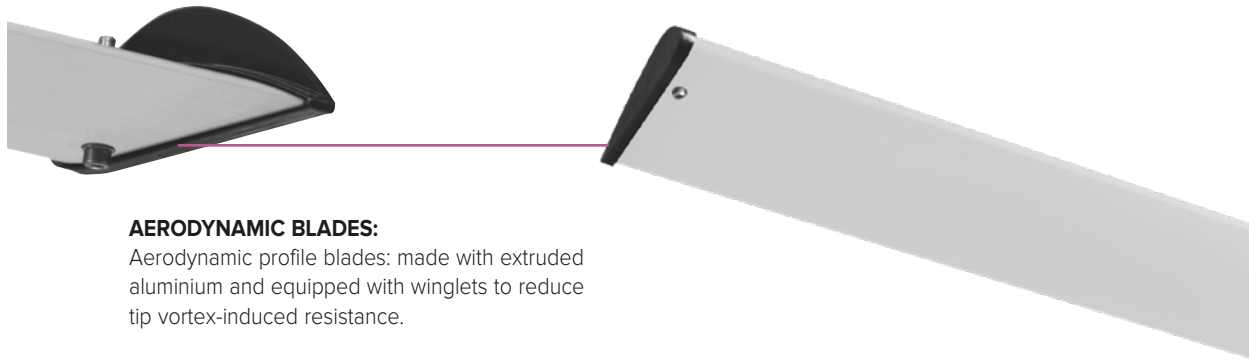

PERFORMANCE:

Very strong air flows (850,000 m³/h) with very low speed to ensure silent functioning.





NORDIK HVLS

SUPER BLADE RANGE

INSTALLATION

Support rod and securing brackets provided with the product.

CONTROLS:

Fully adjustable motor (0-10V signal) via potentiometer or VORT-T control unit.
RS 485 port integrated into motor driver for remote control via BMS system (Modbus RTU protocol).

7

EC MOTORS:

High performance brushless motors, low consumption and wide range of speed adjustments, very high protection (IP65) against dust and water.

Equipped with a new inverter, they differ from each other due to their power supply: single-phase at 85-264 V/50-60 Hz for those identified by the suffix "M", or three-phase at 200-480 V/50-60 Hz for those identified by the suffix "T".

APPLICATIONS





APPLICATIONS

Perfect for any kind of livestock facilities, such as livestock breeding, for improving the animals' and the operators' conditions and well-being.



TECHNICAL CHARACTERISTICS

Available models

- 20 models: available in 5 diameters (300, 400, 500, 600, and 700 cm).

• **Extruded aluminium blades** (available with liquid-paint treatment upon request), which reach high efficiency values and particularly low levels of noise emissions thanks to the sophisticated NACA aerofoil, result of thorough analysis carried out with CFD techniques (Computational Fluid Dynamics), and thanks to winglets which reduce induced drag caused by tip vortices.

- an isolate analogue input to regulate the fan speed through an external potentiometer or any other device that works using a 0 to 10-V signal.
- The safety systems integrated in the electronic parts include protection from overcurrent, short circuit, overheating, overvoltage, and undervoltage; an outside led, with a codified turning-on system, reports any functioning anomalies.

Motors

- Brushless motors, designed to grant high performances, relatively low consumption, and wide ranges of speed regulation. Their high (IP65) degree of protection from dust and water makes them perfect for use in particularly difficult conditions, common in several industrial environments. Possibility to remotely adjust the speed using a potentiometer (0 to 10-V signal) or VORT T unit (optional). Equipped with a new inverter, they differ from each other due to their power supply: single-phase at 85-264 V/50-60 Hz for those identified by the suffix "M", or three-phase at 200-480 V/50-60 Hz for those identified by the suffix "T".

Electronics

- Control and power electronic elements housed in the aluminium fusion of the motor covers, granting adequate protection from water and dust. They manage the power supply and monitor proper functioning, allowing fine adjustments based on the needs of the moment.

With its EMI/EMC filters preventing risks related to electromagnetic interference, NORDIK HVLS SUPER BLADE electronics include:

- an isolated RTU 485 communication modbus allowing the fan to be integrated in a BMS - Building Management System;

Kits

- Steel sheet kit for ceiling installation, including a support rod, a pair of brackets, and other small metal parts, designed to ensure correct and strong installation of the device to the target ceiling through the most common installation processes.
- Optional kit consisting of 4 tie rods specifically designed to ensure an additional degree of axial stability, useful whenever the fan is subject to an external stress of abnormal intensity (e.g. strong wind), or when the destination floor does not meet the required solidity requirements, in relation to the weight of the product and the stresses induced by its operation. In particular, the adoption of the HVLS SUPER BLADE-RD Kit is to be considered mandatory in cases where the chosen position for the installation of the fan:
 - exposes it to wind gusts;
 - exposes it to the risk of accidental impact with moving machines or equipment nearby;
 - exposes it to contact with flying animals;
 - is in a seismic zone, or is subject to strong vibrations (e.g. industrial processes involving the use of power hammers or industrial presses).

Electrical insulation class: I

- Earthing required

Degree of protection of the motor:

- IP65



Dimensions

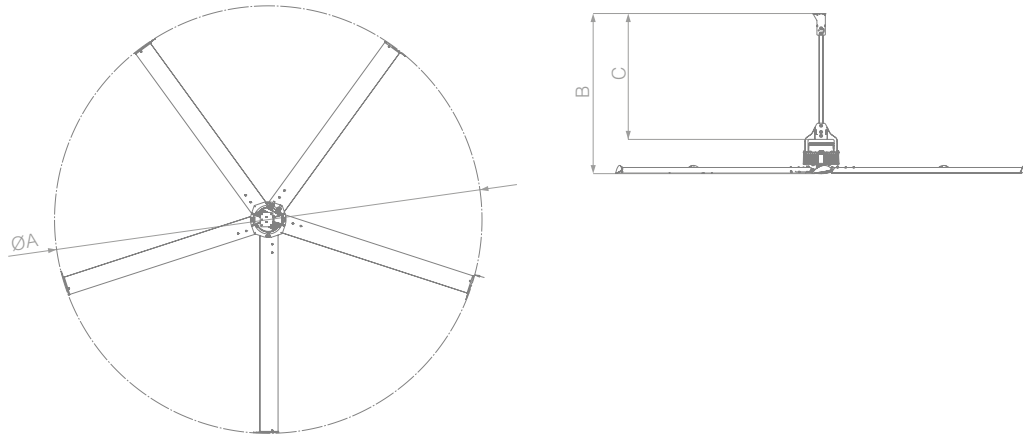

PRODUCTS	CODE	ØA	B	C
NORDIK HVLS SUPERBLADE 300/120° T	61126	3000	1880	1470
NORDIK HVLS SUPER BLADE 300/120° TL	61127	3000	3310	3000
NORDIK HVLS SUPER BLADE 300/120° M	61130	3000	1880	1470
NORDIK HVLS SUPER BLADE 300/120° ML	61131	3000	3310	3000
NORDIK HVLS SUPER BLADE 300/120° ET	61143	3000	1880	1470
NORDIK HVLS SUPER BLADE 300/120° ETL	61144	3000	3310	3000
NORDIK HVLS SUPER BLADE 400/160° T	61128	4000	1880	1470
NORDIK HVLS SUPER BLADE 400/160° TL	61129	4000	3310	3000
NORDIK HVLS SUPER BLADE 400/160° M	61132	4000	1880	1470
NORDIK HVLS SUPER BLADE 400/160° ML	61133	4000	3310	3000
NORDIK HVLS SUPER BLADE 400/160° ET	61145	4000	1880	1470
NORDIK HVLS SUPER BLADE 400/160° ETL	61147	4000	3310	3000
NORDIK HVLS SUPER BLADE 500/200° T	61134	5000	1880	1470
NORDIK HVLS SUPER BLADE 500/200° TL	61135	5000	3310	3000
NORDIK HVLS SUPER BLADE 600/240° T	61136	6000	1880	1470
NORDIK HVLS SUPER BLADE 600/240° TL	61139	6000	3310	3000
NORDIK HVLS SUPER BLADE 700/280° T	61137	7000	1880	1470
NORDIK HVLS SUPER BLADE 700/280° ST	61138	7000	1880	1470
NORDIK HVLS SUPER BLADE 700/280° TL	61141	7000	3310	3000
NORDIK HVLS SUPER BLADE 700/280° STL	61142	7000	3310	3000

Dimensions in mm

NORDIK HVLS SUPER BLADE RANGE
INDUSTRIAL CEILING FANS

Technical data

PRODUCTS	CODE	V~50/60HZ	W	A	RPM	MAX FLOW RATE m ³ /h	Ø m	No. OF BLADES	KG
NORDIK HVLS SUPER BLADE 300/120° T	61126	200-480	600	1.43	160	310.000	3	5	80.5
NORDIK HVLS SUPER BLADE 300/120° T L	61127	200-480	600	1.43	160	310.000	3	5	89
NORDIK HVLS SUPER BLADE 300/120° M	61130	85-264	405	1.98	140	270.000	3	5	70
NORDIK HVLS SUPER BLADE 300/120° M L	61131	85-264	400	1.98	140	270.000	3	5	70
NORDIK HVLS SUPER BLADE 300/120° E T	61143	200-480	725	1.97	150	280.000	3	5	70
NORDIK HVLS SUPER BLADE 300/120° E T L	61144	200-480	725	1.97	150	280.000	3	5	70
NORDIK HVLS SUPER BLADE 400/160° T	61128	200-480	650	1.67	100	370.000	4	5	88
NORDIK HVLS SUPER BLADE 400/160° TL	61129	200-480	650	1.67	100	370.000	4	5	96.5
NORDIK HVLS SUPER BLADE 400/160° M	61132	85-264	280	2.70	80	330.000	4	5	76.5
NORDIK HVLS SUPER BLADE 400/160° M L	61133	85-264	280	2.70	80	330.000	4	5	76.5
NORDIK HVLS SUPER BLADE 400/160° E T	61145	200-480	370	1.01	80	330.000	4	5	76.5
NORDIK HVLS SUPER BLADE 400/160° E T L	61147	200-480	370	1.01	80	330.000	4	5	76.5
NORDIK HVLS SUPER BLADE 500/200° T	61134	200-480	850	1.97	80	530.000	5	5	113
NORDIK HVLS SUPER BLADE 500/200° T L	61135	200-480	850	1.97	80	530.000	5	5	113
NORDIK HVLS SUPER BLADE 600/240° T	61136	200-480	1100	2.69	65	600.000	6	5	121
NORDIK HVLS SUPER BLADE 600/240° T L	61139	200-480	1100	2.69	65	600.000	6	5	121
NORDIK HVLS SUPER BLADE 700/280° T	61137	200-480	900	1.35	38	650.000	7	5	129
NORDIK HVLS SUPER BLADE 700/280° S T	61138	200-480	665	1.65	50	850.000	7	5	140
NORDIK HVLS SUPER BLADE 700/280° T L	61141	200-480	525	1.35	38	650.000	7	5	129
NORDIK HVLS SUPER BLADE 700/280° S T L	61142	200-480	665	1.65	50	850.000	7	5	140

Control units

Code 21137

VORT T



Wire-connected control unit, with LCD display able to manage up to 20 units, VORT T allows to automatically control the speed of the connected fans based on the readings of the temperature sensor and an optional anemometer, increasing or decreasing it to stop depending on the room temperature or, alternatively, based on the wind speed (for, example, this second option is useful for devices installed in stables whose walls have wide outwards openings).

Alternatively, the fan speed can be manually adjusted, regardless of climatic conditions, e.g. for testing the proper functioning of the system during installation or trial.



Control units

Code 20151

VORT T-HCS



Specifically designed to be employed in the zootechnical field, the VORT T-HCS control unit is an optional, wire-connected control device with an LCD display, and is capable to automatically monitor the fans connected based on temperature values, relative humidity, and THI (Temperature Humidity Index), the bioclimatic index that combines the simultaneous effect of temperature and relative humidity and is used to determine heat-induced stress in the livestock. VORT T-HCS allows the automatic management (ON/OFF up to 4 strokes) of the optionally installed cylinders, the limitation or interruption of the ventilation upon start, and the management of the auxiliary ventilation (if present). Alternatively, fan speed and cylinder control can be manually adjusted, regardless of climatic conditions, e.g. for testing the proper functioning of the system during installation or trial.

Code 20152

VORT T-PLUS



It is a PLC unit, designed to control the microclimate in livestock breeding facilities; thanks to VORT T-PLUS it is possible to plan the operation of each device installed based on the temperature, humidity, and wind speed values detected.

In particular, VORT T-PLUS:

- controls the wind speed, stopping ventilation in case of need / opportunity;
- controls the ventilation, operating (0 to 10-V signal) the EC motors of the connected fans;
- controls up to 4 cylinders with 4 on-off programmable levels;
- controls the humidity by blocking cylinder commands, if needed;
- manages max/min temperature alarms;
- detects perceived temperature and THI;
- controls functioning hours and milking break;
- communicates with VORT MASTER through an integrated RS-485 port.

Everything is regulated by an intuitive programming plan, adaptable to every need of the sector.

The 9-module DIN rail container makes VORT T-PLUS easy to be installed in electrical panels.

The 8-segment display allows to see the indications from the distance: the various machine statuses are highlighted by specific LEDs indicating the functioning activities. It can be programmed in a sequential and simple way through a keyboard with 8 keys.

Code 20153

VORT MASTER



Specifically designed to be used in the zootechnical field, the VOLT MASTER control unit guarantees the monitoring of the microclimate in cattle breeding facilities by managing ventilation, air speed, cylinders, (temperature and amperometric) alarms, based on temperature, humidity, THI, air speed, and other values detected by the sensors installed. Thanks to the graphic interface of the LCD touch panel, VORT MASTER allows to adjust, in an easy and intuitive way, the speed of the connected fans, and to monitor its proper functioning in real time. Through the Ethernet port, VORT MASTER can also be connected to a network router and remotely controlled; at the same time, the VNC (Virtual Network Computing) technology allows its quick and easy connection to smartphones, tablets, and personal computers.

Regulators and accessories

Regulators



POT Code 12828

Potentiometer for fan regulation using 0 to 10-V signal.



POT-I Code 12832

Built-in potentiometer for fan regulation using 0 to 10-V signal.

Accessories



USB-C Code 21198

USB ModBus converter connectible to the VORT control unit, useful to remotely manage the fan(s).



WP Code 21197

External anemometer connectible to VORT T control unit, useful to automatically control the fan in case of wind gusts.

Suspension tie rods kit

Code 20193

NHVLS SUPER BLADE - RD tie rod kit

Optional kit including four tie rods, designed to ensure a solid and safe installation.



This kit is mandatory in case of:

- strong wind;
- risk of accidental impact with machines or other objects moving close to the ceiling fan;
- presence of birds;
- installation in seismic zones or other areas with vibrations (e.g. industrial processes involving the use of hammers or industrial presses).



Anchoring brackets

Code 20267

STF 1

Anchoring bracket on steel beams. Option 1

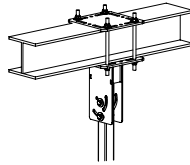

Code 20268

STF 2

Anchoring bracket on steel beams. Option 2

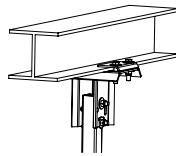

Code 20269

STF 3

Anchoring brackets kit with existing structure 3m-5m. Rod not supplied

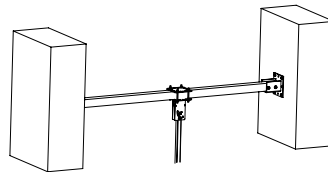

Code 20270

STF 4

Anchoring brackets kit with hinge included.
(3 m length)

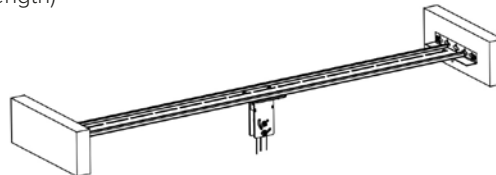

Code 20271

STF 5

Anchoring brackets kit with omega beam.

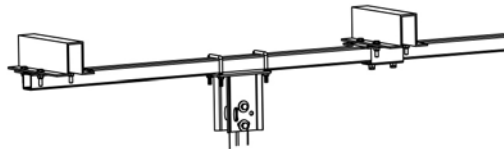

Code 20272

STF 6

Bracket kit for anchorage on joist under a windshield (2 m length)

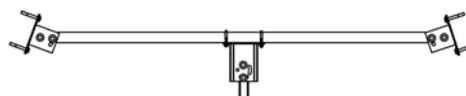

WHY INSTALL A CEILING FAN AND WHY A NORDIK HVLS SUPER BLADE PARTICULARLY

Rotating, a ceiling fan generates an air column moving downwards and outwards along the floor. The width of this column increases with the diameter of the fan and, to a lesser extent, with its rotating speed.

A fan with a wider diameter can move a bigger air mass than a smaller fan spinning at the same speed; at the same time, an air column moving faster dissipates faster. Furthermore, the propagation distance of the air column produced by the fan increases with its diameter as a result of the action, more limited in proportion, exerted by the friction of the still air around it.

In the light of the above, the use of ceiling fans of the NORDIK HVLS SUPER BLADE series, which boast a high (IP65) degree of resistance to water and dust, offers a wide range of temperatures in continued operations (-10 °C to +50 °C) and of speed regulation. They are particularly suitable for industrial environments (such as warehouses, depots, stables, etc.), where the use of air conditioning systems would be impossible or too expensive, as well as for commercial areas (such as supermarkets, gyms, airports, etc.), where their action allows significant savings in connection with the amplification of the effects of any already existing air conditioning systems and with air destratification.

16

MOREOVER, INSTALLING A CEILING FAN OR A NORDIK HVLS SUPER BLADE PROVIDES SIGNIFICANT BENEFITS IN BOTH SUMMER AND WINTER

SUMMER USAGE

As it is known, high temperatures and high relative humidity levels make environmental conditions uncomfortable and, in some cases, they can affect the occupants' productivity. In normal conditions, the human body needs to heat down when environmental temperatures exceed 23 °C ca. Air conditioners lower the room temperature, while fans accelerate the air speed around the occupants, making it easier for them to cool down and helping heat transfer by convection and sweat evaporation, while the temperature remains the same.

WINTER USAGE

Warm air, less dense than cold air, accumulates near the ceiling, resulting in a phenomenon known as "stratification". The implementation of fans that push warm air downwards helps mix the air ("destratification"), useful to solve the problem, while guaranteeing significant savings both in term of smaller energy dissipation through walls and roof, and smaller caloric intake necessary to maintain adequate temperature levels for the occupants.

THERMAL DESTRATIFICATION

WELL-BEING AND ENERGY SAVING EVEN IN WIDE INDUSTRIAL AND COMMERCIAL ENVIRONMENTS THANKS TO CEILING FANS

Adequate comfort conditions and air quality are key elements in a work environment. In wide commercial and industrial spaces with very high ceilings, however, it is hard to ensure adequate heating during all working hours. The energy costs are high and the results are not very satisfying.

The heat generated by the heating systems (radiators, air-heaters, etc.) rises upwards in convective motion and stratifies near the ceiling, leaving the areas near the floor colder. In industrial depots, shopping centres, museums, or places of worship, it often happens that, in order to keep 18 °C at “eye level”, the air temperature near the ceiling exceeds 30-35 °C. Under these conditions, the well-being of those who frequent the place decreases, while the costs to keep the ideal temperature grow immensely.

The solution to this problem is thermal destratification using ceiling fans. If well-placed, ceiling fans create a perfect mix between warm air and cool air even at low speed, keeping a uniform temperature. This comes with all the advantages in comfort and effective reduction of energy consumption. Specific studies show that the savings provided by the application of thermal destratification systems in particular commercial and industrial environments can amortise the system purchase and installation expenses in just 4 years.

Especially since ceiling fans are more often used during summertime **to eliminate stagnation and humidity and to allow adequate air circulation.**

VORTICE has the ideal know-how, experience, and range of products to install thermal destratification systems in wide environments. Our qualified technicians are at our clients' disposal for designing and creating customised solutions, also using thermal-fluid-dynamic simulation systems. The pictures in these pages are taken from a simulation made by the VORTICE R&D department on a study commissioned by a client and later experimentally confirmed.

INDUSTRIAL BUILDING EXAMINED: MODEL LAYOUT



CEILING FANS

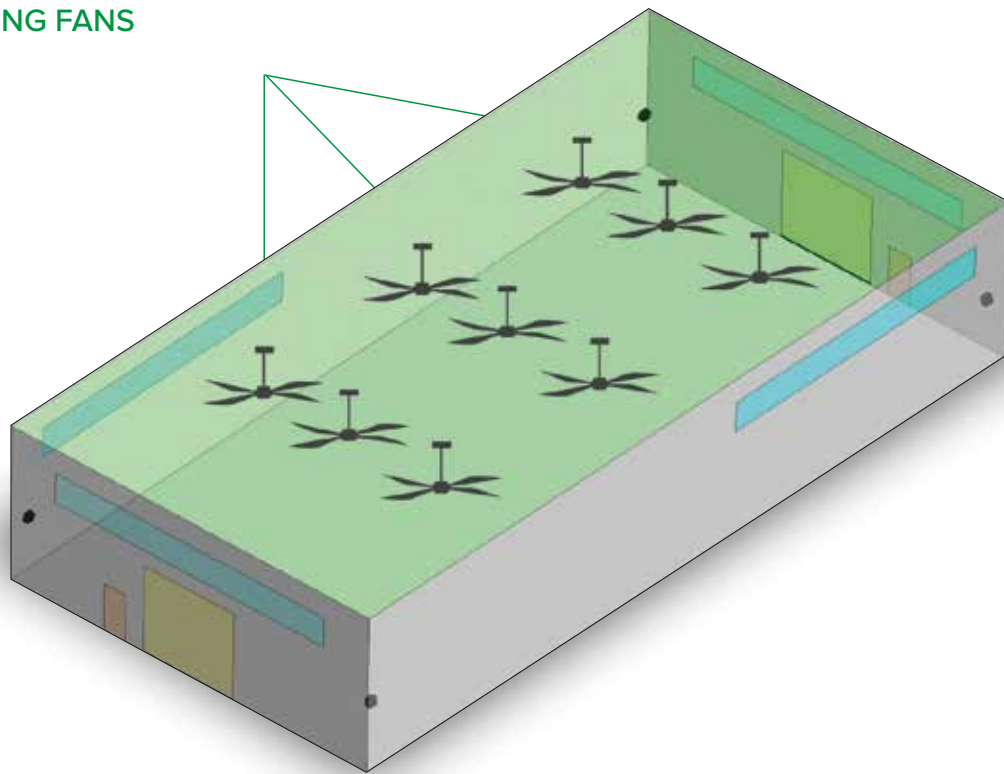

4 THERMAL FANS

FROM 12KW (TOTAL 48KW)

(FREE CONVECTION, CEILING FANS = OFF)

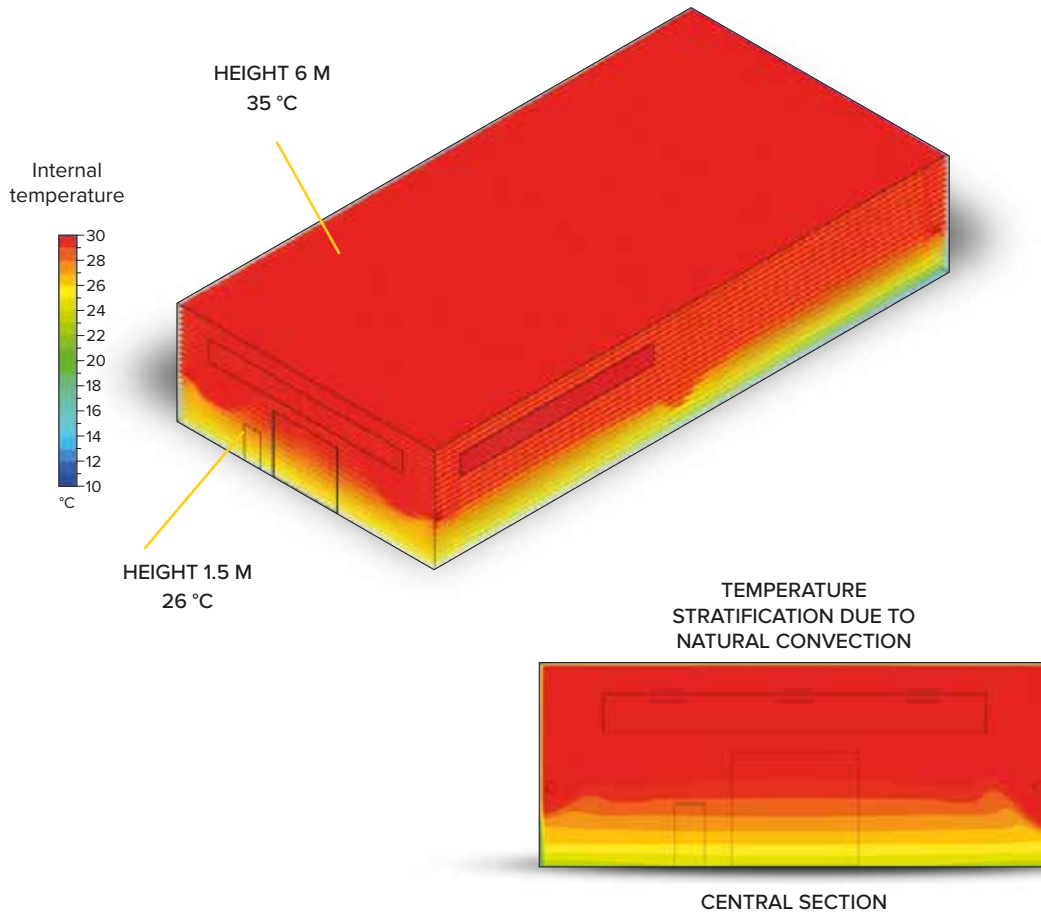

20

“STANDARD” INDUSTRIAL BUILDING (ONLY HEATING SYSTEM ON): DISTRIBUTION OF INTERNAL TEMPERATURE

Simple heating system with 4 thermal fans, with a total power of 48 kW, manages to reach a minimum temperature of 20 °C inside the building, but characterised by an inefficient temperature stratification in height caused by natural convection.

NO. 4 HEAT FANS OF 9 KW (TOTAL 36 KW)

(CEILING FANS = ON)

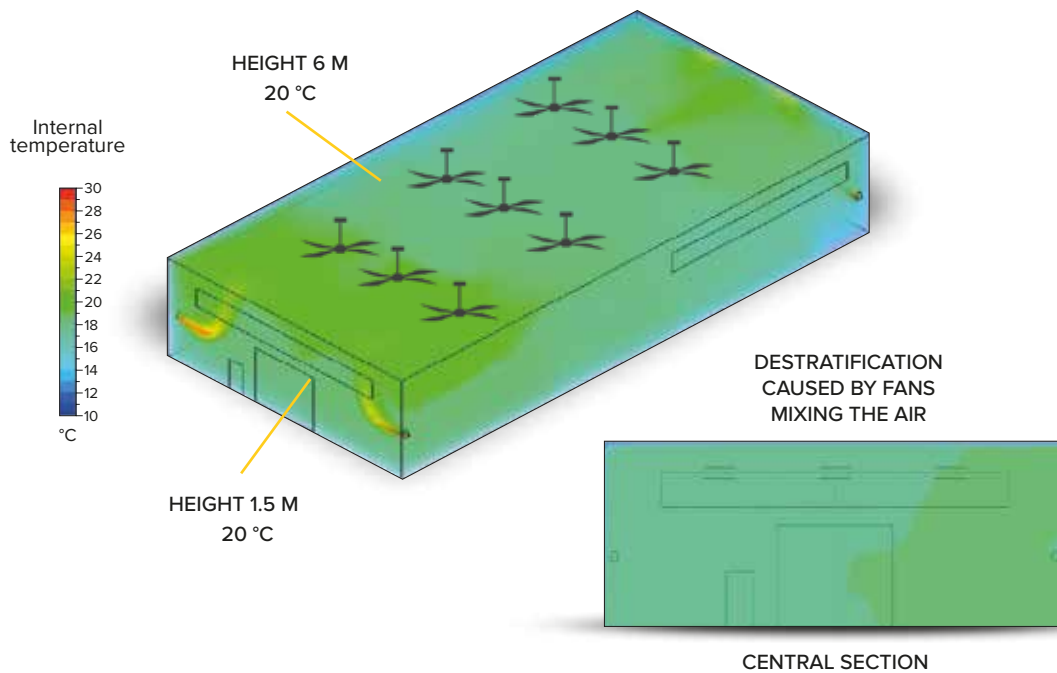

DESTRATIFICATED AIR: INTERNAL TEMPERATURE DISTRIBUTION

Low-speed fan operation creates a uniformly heated and comfortable environment, reaching the desired temperature of 20 °C with reduced energy consumption levels.

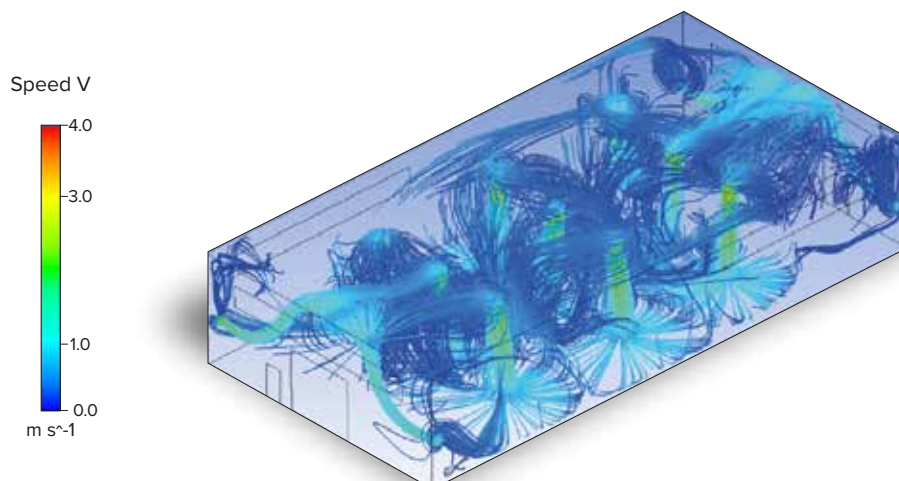

AIR SPEED FLOW LINES DURING FAN OPERATION

Even at low speed, the fans can efficiently mix warm air and cool air without any side effects on the occupants in the building.

NORDIK HD RANGE

Design and manufacturing
MADE IN ITALY

Industrial fans

3-blade reversible ceiling fans, available in the variants with 120, 140, 160, and 200 cm diameter. Designed for continued use, even at maximum speed in environments with high relative humidity levels, high temperatures and high concentration of dust and corrosive vapours, common in process industries, agricultural facilities, greenhouses etc.

22



NORDIK HEAVY DUTY

NORDIK HEAVY DUTY INOX

INOX MODELS

BLADES, RODS and COVERS in stainless steel sheet AISI 304, a nanostructured treatment that increases its resistance to corrosion and makes cleaning easier. ENGINE HOUSINGS coated with black epoxy powder, embossed finish.



BENEFITS FOR THE INSTALLER

01

Easy installation

Easy and safe installation

BENEFITS FOR THE USER

01

Low costs

Maximum efficiency, low costs

02

Energy saving

They cool the environment in summer, while destratifying heat in winter, saving energy

03

Silent

Silent even at maximum speed

04

Reliable

Reliable, safe and efficient

05

Maintenance-free

06

Adjustable speed

Guaranteeing maximum comfort and environmental well-being

NORDIK HD RANGE

NORDIK HEAVY DUTY 120 code 61020 - **NORDIK HEAVY DUTY 140** code 61021
NORDIK HEAVY DUTY 160 code 61022 - **NORDIK HEAVY DUTY 200** code 61023

Electro-galvanised steel sheet covers, treated with epoxy primer and subsequent black epoxy coating and hammer finish.



Support device made of a 4-hole plate for strongly and durably securing the product even to sloped ceilings.

Wide choice of support rods of different lengths to better match the needs of the target environment.

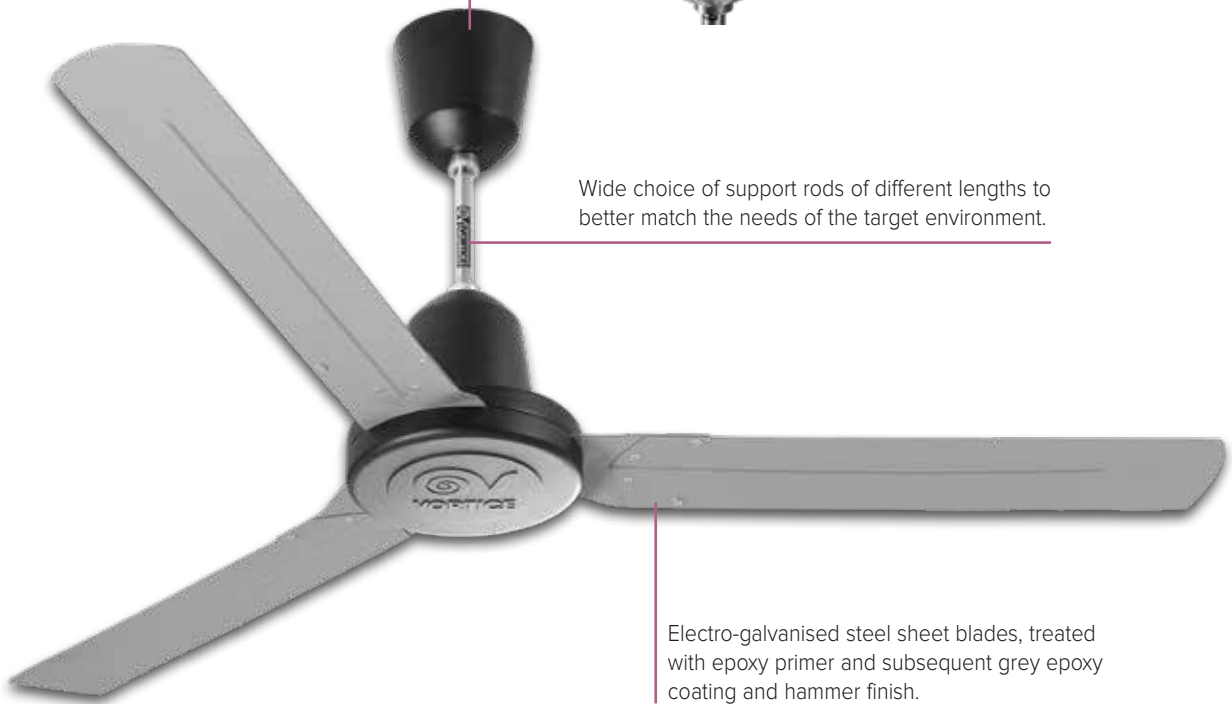

Electro-galvanised steel sheet blades, treated with epoxy primer and subsequent grey epoxy coating and hammer finish.





NORDIK HD RANGE

NORDIK HEAVY DUTY 120 INOX code 61024 - **NORDIK HEAVY DUTY 140 INOX** code 61025
NORDIK HEAVY DUTY 160 INOX code 61026 - **NORDIK HEAVY DUTY 200 INOX** code 61027

BLADES, RODS and COVERS in AISI 304 stainless steel sheet, with a nanostructured treatment to increase their resistance to corrosion and make them easier to clean.
MOTOR HOUSINGS coated in black epoxy powder, embossed finish.

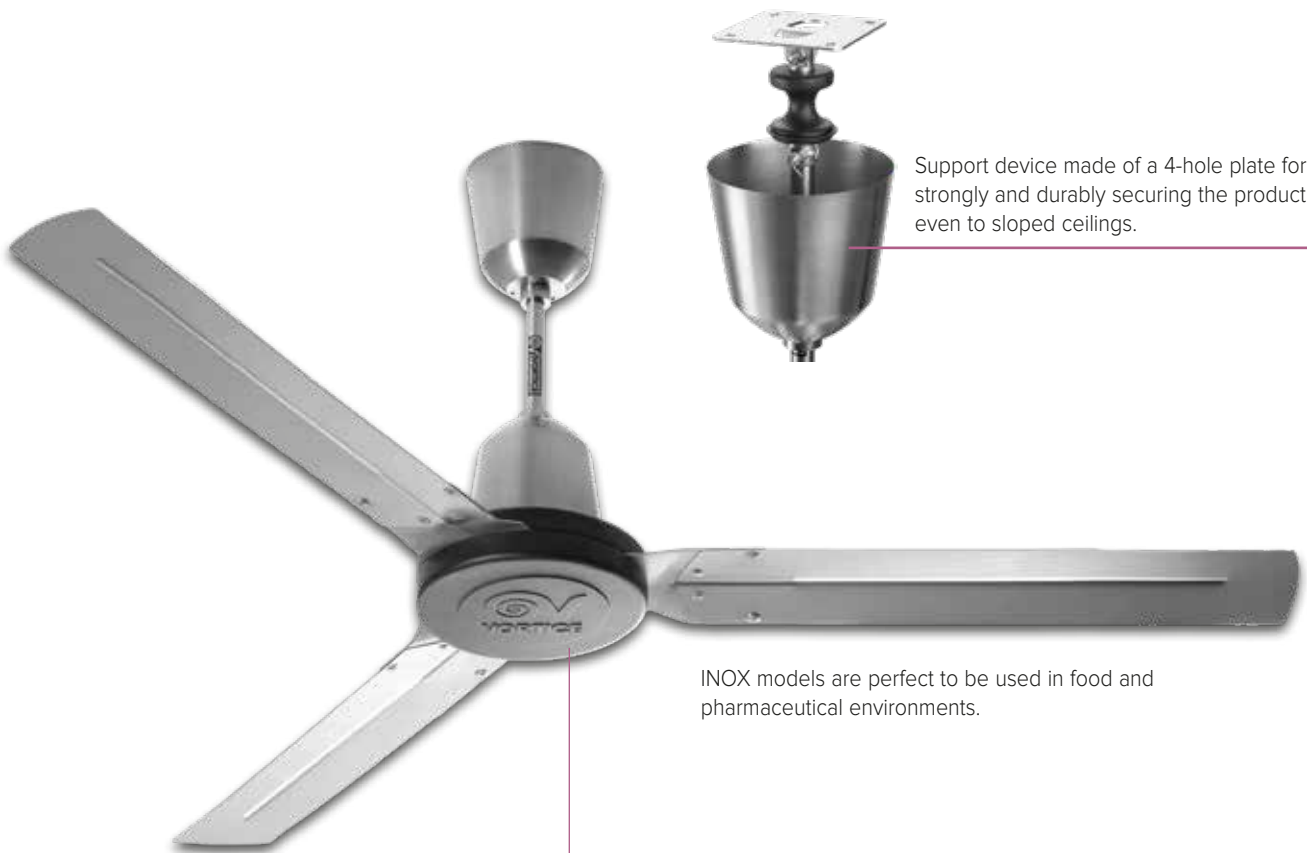

Support device made of a 4-hole plate for strongly and durably securing the product even to sloped ceilings.

INOX models are perfect to be used in food and pharmaceutical environments.

Motor covers coated in black epoxy powder and embossed finish.



APPLICATIONS



The high degree of dust and water protection (IP55) makes them particularly suitable for humid environments such as greenhouses.

Perfect for any type of farming facilities, such as livestock breeding, fully respecting animal well-being.





APPLICATIONS

Designed for continuous use in environments with high rates of humidity and high temperatures (up to 50° C ambient).



INOX versions are perfect to be used in food and pharmaceutical environments.



TECHNICAL CHARACTERISTICS

Available models

- 8 models: available in 4 dimensions with 120, 140, 160 and 200-cm blades with zinc-coated stainless steel sheet finish.
- **BASE models** are made of electro-galvanised steel sheet blades, treated with epoxy primer and subsequent grey epoxy coating and hammer finish; electro-galvanised steel sheet covers, treated with epoxy primer and subsequent black epoxy coating and hammer finish.
- **INOX models** have blades, rods and covers in AISI 304 stainless steel sheet with a further nanostructured treatment which increases resistance to corrosion and makes cleaning easier. Motor covers are in die-cast aluminium, coated in black epoxy powder and embossed finish.
- Equipped with a 290-mm support rod.
- Support devices with a 4-hole plate for strongly and durably securing the product, which can be perfectly installed on very sloped ceilings.

Motors

- Self-protecting motors with external rotor. They can spin both clockwise and anti-clockwise, and they are specifically designed to work for long periods at maximum rating temperature or in hard conditions thanks to:
 - impregnated stator winding, to grant a better electrical insulation;
 - rotors with small magnetic steel sheets with high content of fused silica wrapped in a 99.9% pure aluminium, in a structural aluminium alloy shell;
 - housings made of two die-cast covers, coated in black epoxy powder, embossed finish, to grant high resistance to corrosion in time; synthetic rubber (EPDM) circular gaskets placed between the two shells, guaranteeing high resistance to water and dust, essential requirement for long-term usage even in highly critical environments;
- two ball-bearings placed on the upper cover in order to prevent the risk of misalignment that could lead to malfunctions in time.

28

Terminal block

- for accessing the network, placed in a specific box protected from dust and water.

Safety cable

- compliant with the most recent international security standards for ceiling fans, in order to prevent the risk of falling due to wrong installation.

Shock absorber

- made up of an elastic rubber element overprinted on an internal steel cable, designed to resist repeated start/stop cycles of the product, even at maximum speed (the life tests conducted allow to guarantee a lifetime of 50 years of uninterrupted operation).

Accessories

- Accessory bag containing all small parts necessary for installing the blades, the hook and the anti-vibration rubber for the anchorage to the ceiling.

Electrical insulation class: I

- Earthing required

Degree of protection against dust and water:

- IP55



Dimensions

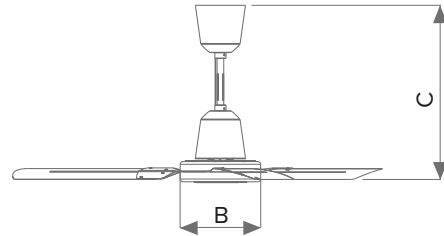
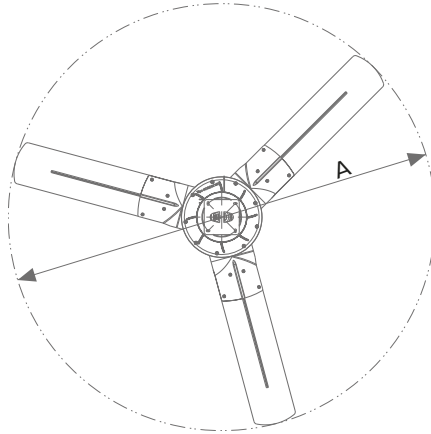

PRODUCTS	CODE	ØA	ØB	C
NORDIK HEAVY DUTY 120	61020 - 61024	1218	230	495
NORDIK HEAVY DUTY 140	61021 - 61025	1422	230	495
NORDIK HEAVY DUTY 160	61022 - 61026	1524	230	495
NORDIK HEAVY DUTY 200	61023 - 61027	2000	230	495

Dimensions in mm

Technical data

PRODUCTS	CODE	COLOUR	V~50	W	A	RPM	MAX FLOW RATE m ³ /h	No. OF BLADES	KG
NORDIK HEAVY DUTY 120	61020	GREY/BLACK	230	80	0.35	233	14050	3	7.7
NORDIK HEAVY DUTY 120 INOX	61024	INOX	230	80	0.35	233	14050	3	7.7
NORDIK HEAVY DUTY 140	61021	GREY/BLACK	230	80	0.35	236	16000	3	8.1
NORDIK HEAVY DUTY 140 INOX	61025	INOX	230	80	0.35	236	16000	3	8.1
NORDIK HEAVY DUTY 160	61022	GREY/BLACK	230	85	0.37	210	19300	3	8.6
NORDIK HEAVY DUTY 160 INOX	61026	INOX	230	85	0.37	210	19300	3	8.6
NORDIK HEAVY DUTY 200	61023	GREY/BLACK	230	85	0.38	186	22050	3	9.5
NORDIK HEAVY DUTY 200 INOX	61027	INOX	230	85	0.38	186	22050	3	9.5

Technical data for regulation No. 206/2012/EU

CODE	FLOW RATE PARAMETER	UNIT OF MEASUREMENT	HEAVY DUTY 120	HEAVY DUTY 140	HEAVY DUTY 160	HEAVY DUTY 200
			61020 - 61024	61021 - 61025	61022 - 61026	61023 - 61027
Maximum air flow rate	F	m ³ /min	234.00	266.60	321.60	367.50
Power absorbed by the fan	P	W	80	80	85	85
Strike values	SV	(m ³ /min)W	2,925	3,332	3,780	4,320
Stand-by mode	PSB	KW	-	-	-	-
Noise level	LWA	dB(A)	51.8	55.4	55.6	56.4
Air speed	C	m/sec	2.40	2.01	1.85	1.35
Measure name for strike value	IEC 60879; EN62301: UNI EN ISO 3741					

For more information, please refer to: VORTICE Spa, Strada Cerca, 2 - 20067 Zoate di Tribiano (MI) Italy

Accessories

VORT DELTA T (code 13039)
MULTIPLE SPEED REGULATOR FOR UP TO 16 CEILING FANS



VORT DELTA T smart control system:

- The Vort Delta T control unit is equipped with two sensors, included in the package, which must be installed respectively at the level of the ceiling and floor.
- Power supply requires a normal two-phase cable, up to 50 metres.
- The control unit detects the temperature on the ceiling and at floor level up to 60 times per minute, calculates the temperature differential and, in accordance with it, adjusts the operating speed of the ceiling fans. When the heat layer has been dissipated and the temperature differential has been reduced to an acceptable level, the Vort Delta T automatically turns off the fans.
- It is possible to adjust the minimum temperature differential at which the unit will activate, as well as the speed. This also applies to continued use (for example, for cooling in summer).
- This completely automatic control system perfectly regulates the system without the need to manually adjust it.
- Monophase power supply: 230 V / 50-60 Hz
- Maximum power absorbed (A): 6.0
- Degree of protection: IP54

EXAMPLE OF WINTER DESTRATIFICATION

- 1 The business building has a warm-air heating system. Thanks to the adjustable sheet blades, warm air is pushed downwards to recreational or working areas.
- 2 Since warm air has a smaller specific weight than cold air, it rises back to the ceiling area and it accumulates there. The sensor controls detect the growing temperature difference between the floor and the ceiling. Nordik fans are controlled so that warm air in the ceiling is pushed back to recreational or working areas. As soon as the temperature difference between the floor and ceiling areas is balanced, the Vort Delta T system automatically switches off the ceiling fans.
- 3

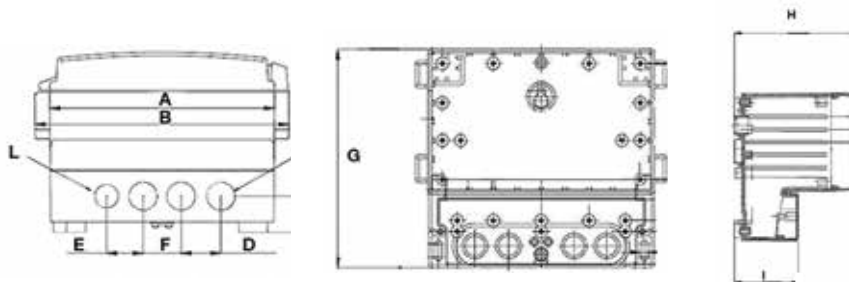
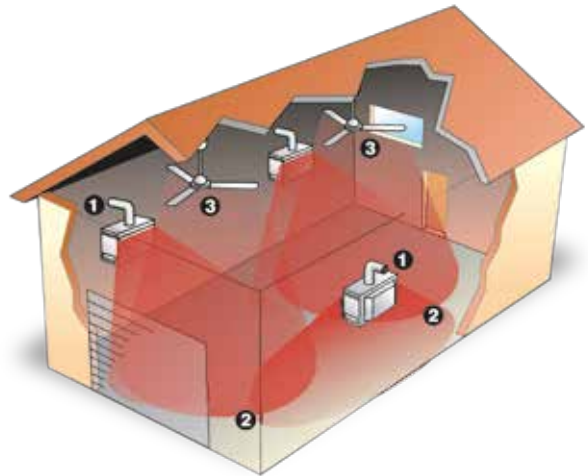

PRODUCTS	A	B	C	D	E	F	G	H	I	ØL
VORT DELTA T	166	1218	20	29.5	27	28	160	134	69	16

Dimensions in mm



Accessories

SCRR5
(code 12963)



- 5-speed reversible command boxes for fans with no light.
- It can be made recessed with SCBRR5/5L/M kit, code 22489.
- Power supply: 220-240 V / 50 Hz.
- Max absorbed current: 100 W.
- Insulation: Cl. II
- Gost approval.

SCRR/M
(code 12965)



- Reversible command boxes with continuous speed regulation, max 6 fans.
- It can be made recessed with SCBRR5/5L/M kit, code 22489.
- Power supply: 220-240 V / 50 Hz.
- Max absorbed current: 450 W (2.5 A)
- Insulation: Cl. II

SCBRR5/5L/M RECESSED KIT
(code 22489)



- To transform boxes 5-speed commands from external to recessed.

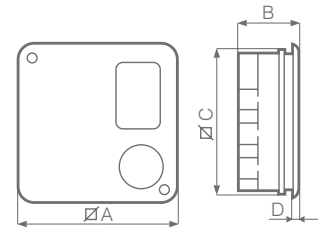
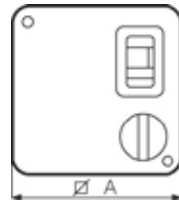
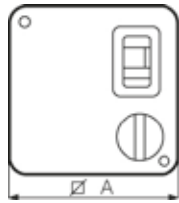

PRODUCTS	∅A	B	KG
SCRR5	120	55	0.58

Dimensions in mm

PRODUCTS	∅A	B	KG
SCRR/M	120	43	0.20

PRODUCTS	∅A	B	∅C	KG
SCBRR5/5L/M	142	59.5	135	4.50

RODS

Useful if you need to move the fan closer or further away from the ceiling for aesthetic or functional reasons.



GREY/BLACK
290-mm HD rod (code 22717)
665-mm HD rod (code 22718)
915-mm HD rod (code 22719)

Rods made of galvanized sheet steel with AISI 304, a nanostructured treatment that increases its resistance to corrosion and makes it easier to clean.



INOX
290-mm HD rod (code 22721)
665-mm HD rod (code 22722)
915-mm HD rod (code 22723)

VORTICE GROUP COMPANIES

VORTICE S.P.A

Strada Cerca, 2
District of Zoate
20067 Tribiano
(Milan) Italy
Tel. (+39) 02 906991
Fax (+39) 02 90699625
vortice.com

VORTICE LIMITED

Beeches House
Eastern Avenue
Burton on Trent
DE13 0BB United Kingdom
Tel. (+44) 1283-49.29.49
Fax (+44) 1283-54.41.21
vortice.ltd.uk

VORTICE INDUSTRIAL S.R.L.

Via B. Brugnoli 3,
37063 Isola della Scala
(Verona) Italy
Tel. (+39) 045 6631042
Fax (+39) 045 6631039
vorticeindustrial.com

CASALS VENTILACIÓN AIR INDUSTRIAL S.L.

Ctra. Camprodon, s/n 17860
Sant Joan de les Abadesses
(Girona) Spain
Tel. (+34) 972720150
casals.com

VORTICE LATAM S.A.

Bodega #6
Zona Franca Bes Alajuela,
Alajuela 20101
Costa Rica
Tel. (+506) 2201.6934
vortice-latam.com

VORTICE VENTILATION SYSTEM

(Changzhou) Co.LTD
No. 388 West Huanghe Road
Building 19, Changzhou
Post Code: 213000 China
Tel. (+86) 0519 88990150
Fax (+86) 0519 88990151
vortice-china.com

The descriptions and illustrations in this catalogue are intended to be indicative and not binding. Without prejudice to the essential characteristics of the products described and illustrated here, VORTICE reserves the right to make, at any time and without notice, any changes to parts, aesthetic details or supply of accessories to its products that are deemed to be appropriate for improvement or for any construction or commercial requirement. This printout completely cancels and replaces all previous ones.

